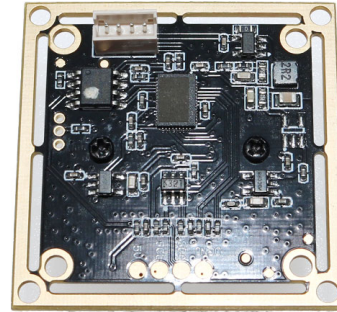

YDS-USB-0789 V1**5MP Sony IMX335 M12 Fixed Focus USB 2.0 Camera Module**

YDS-USB-0789 V1 is a 5MP Fixed Focus USB camera module based on 1/2.8" IMX335 image sensor. It delivers high-speed, 2K resolution ultra sharp image.

The S-mount (M12) lens holder enables customers to choose different lens as per varies applications. This camera module is ideal solution for face recognition, identity detection, automotive, access control.

Key Features

- 2K resolution (2592 x 1944) Sony IMX335 sensor
- High speed USB 2.0 Plug and Play
- MJPG and YUV2 output format
- Low power consumption
- Compact size
- UVC compliant to Windows, Linux, OS with UVC driver
- USB OTG (On-The-Go) support



YDS CAMERA MODULE

your best camera partner

YDS-USB-0789 V1

5MP Sony IMX335 M12 Fixed Focus USB 2.0 Camera Module

Camera Module No.	YDS-USB-0789 V1
Resolution	5MP
Image Sensor	IMX335
Sensor Type	1/2.8"
Pixel Size	2.0 um x 2.0 um
EFL	3.00 mm
F.NO	2.40
Pixel	2592 x 1944
View Angle	90°(DFOV)
Lens Dimensions	14.40 x 14.40 x 19.68 mm
Module Type	Fixed Focus
Lens Model	YDS-LENS-0789 V1
Interface	USB 2.0
Output Format	MJPEG / YUV2
Auto Control	Saturation, Contrast, Acutance White Balance, Exposure
Audio	Digital Microphone, Single, Dual Channel
Input Voltage	DC 5V
Working Current	Max 500mA
PCB Size	38mm x 38mm / 32mm x 32mm
System Compatibility	Windows XP (SP2, SP3), Vista, 7, 8, 10, 11 Android, Mac OS, Linux or OS with UVC Driver Raspberry Pi by USB Port
Software for USB Camera	AMCAP, Webcam Viewer, V4L2 Controls Contacam, VLC Player, MotionEye OS iSpy, ZoneMider, Yawcam
Lens Type	650nm IR Cut
Operating Temperature	-30°C to +85°C
USB Cable	YDS-Cable-U015

Wide Compatibility with Windows, Android, Mac OS, Linux, or Raspberry Pi



Windows®



Android



Mac OS



Linux



Raspberry Pi

www.YDSCAM.com sales@ydscam.com Phone (WeChat, QQ): (+86) 177 2732 6718

All rights reserved @ YingDeShun Co. Ltd. Specifications subject to change without notice.



YDS-USB-0789 V1 5MP Sony IMX335 M12 Fixed Focus USB 2.0 Camera Module



Top View

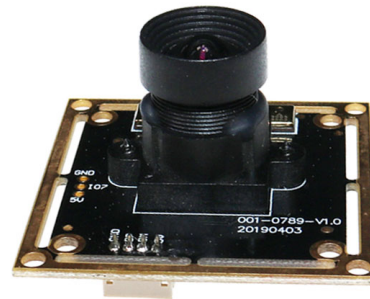

Side View



Bottom View



Mating Connector

YDS-USB-0789 V1

5MP Sony IMX335 M12 Fixed Focus USB 2.0 Camera Module

FORMAT	RESOLUTION	FRAME RATE
		USB 2.0
MJPEG	640 x 480 (VGA)	30 FPS
	1280 x 720 (720P)	30 FPS
	1920 x 1080 (1080P)	30 FPS
	2592 x 1944 (5MP)	30 FPS
YUY2	640 x 480 (VGA)	30 FPS
	1280 x 720 (720P)	10 FPS
	1920 x 1080 (1080P)	5 FPS
	2592 x 1944 (5MP)	2 FPS







YDS CAMERA MODULE

your best camera partner

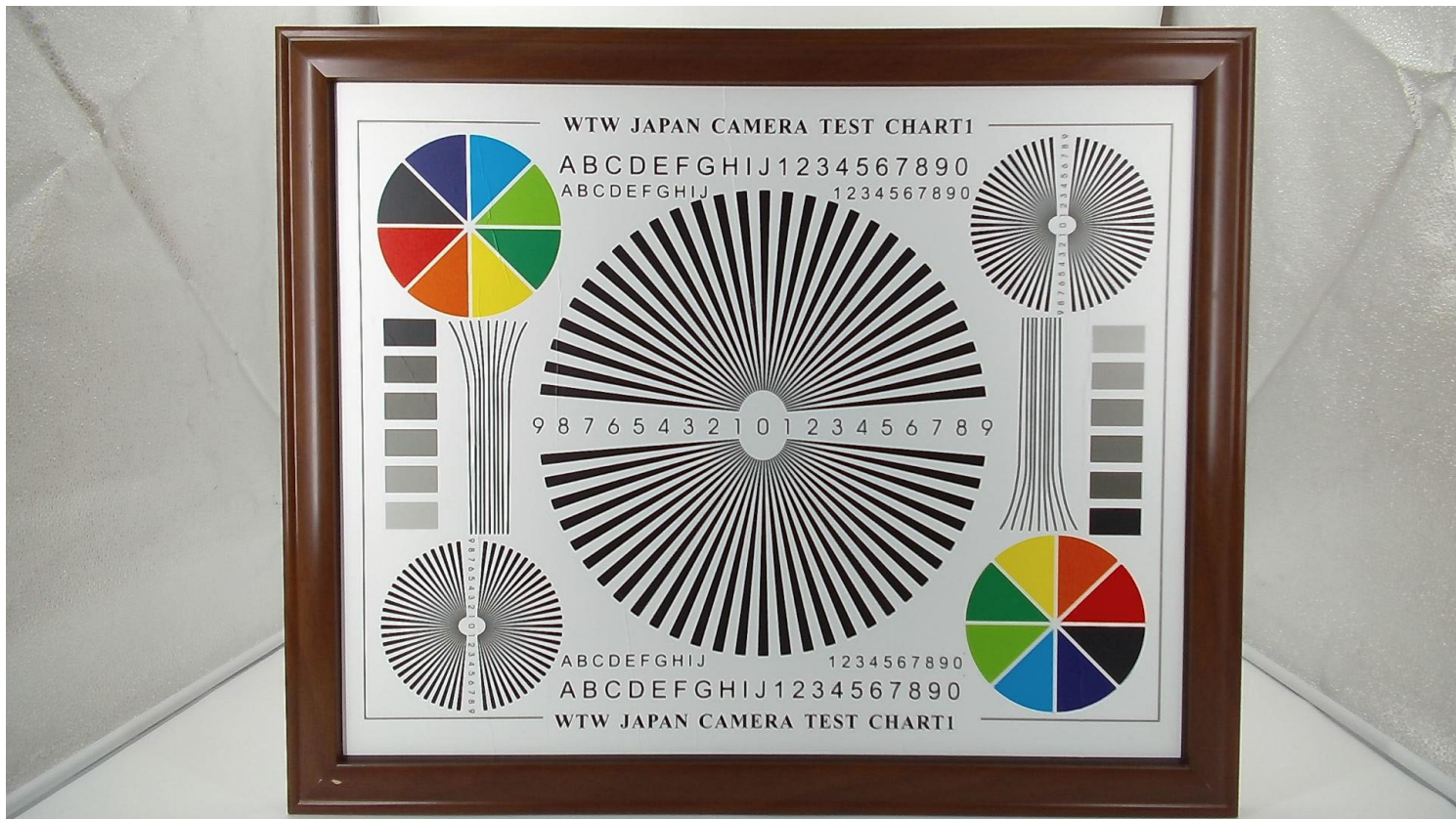
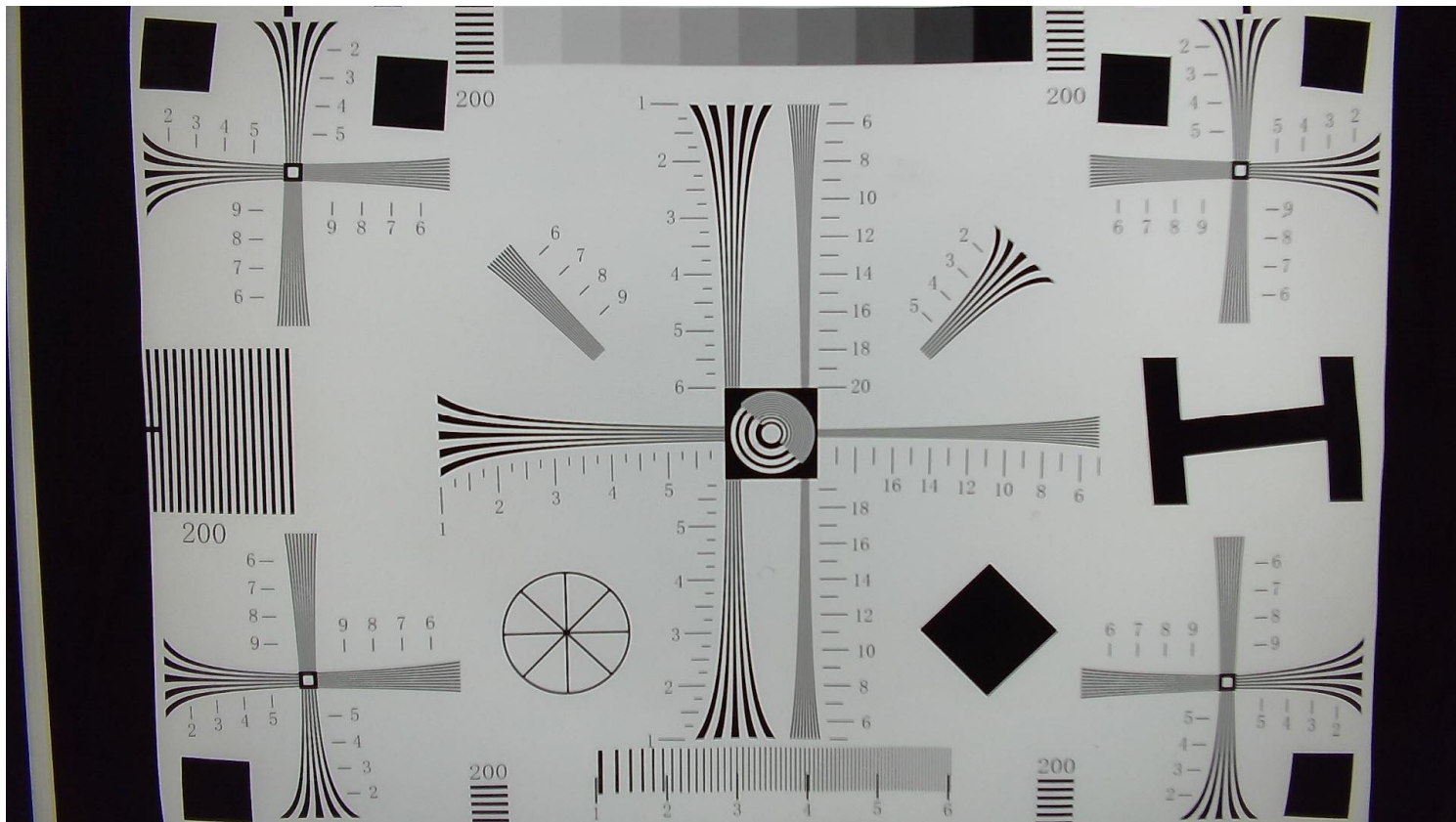

www.YDSCAM.com sales@ydscam.com Phone (WeChat, QQ): (+86) 177 2732 6718

All rights reserved @ YingDeShun Co. Ltd. Specifications subject to change without notice.



YDS CAMERA MODULE

your best camera partner

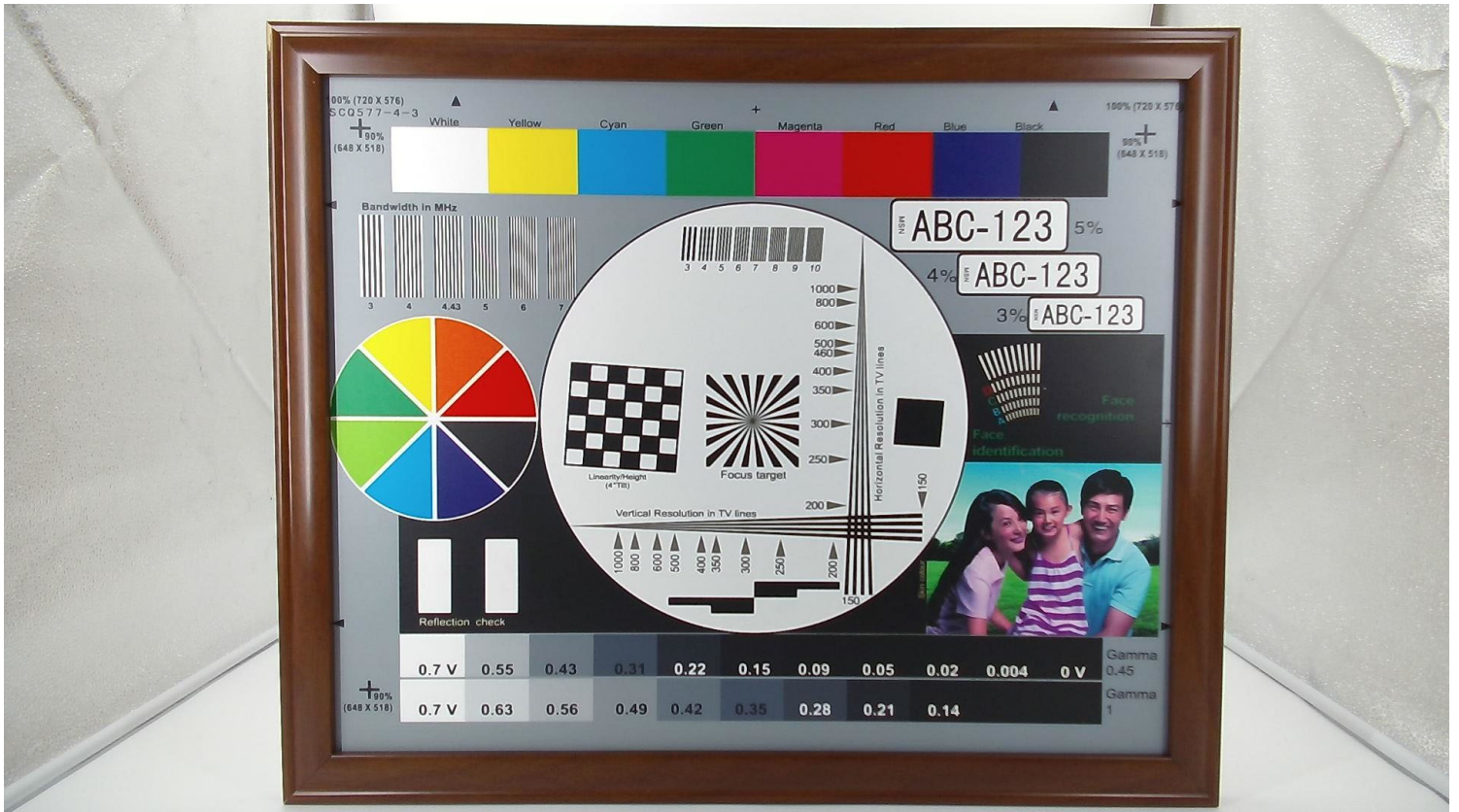

www.YDSCAM.com sales@ydscam.com Phone (WeChat, QQ): (+86) 177 2732 6718

All rights reserved @ YingDeShun Co. Ltd. Specifications subject to change without notice.

Version	Information	Date
V1.0	First Version	5-25-2022

PIN NO	SIGNAL
PIN1	USB 5V
02	D-
03	D+
04	DGND

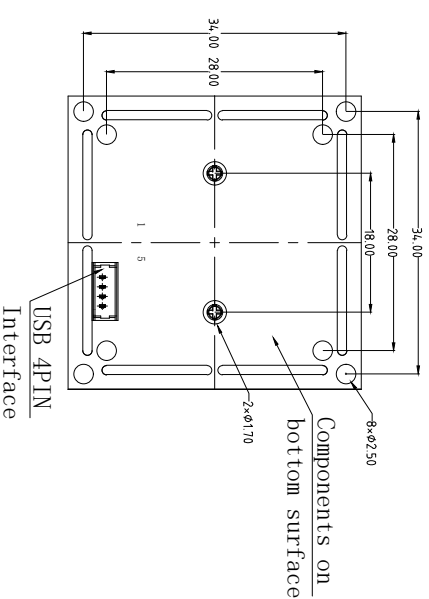
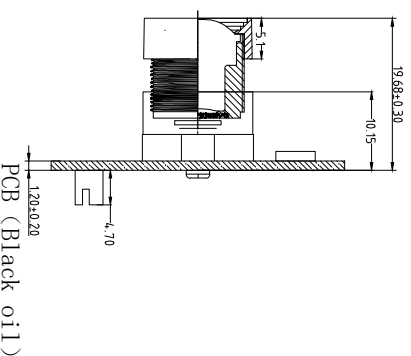
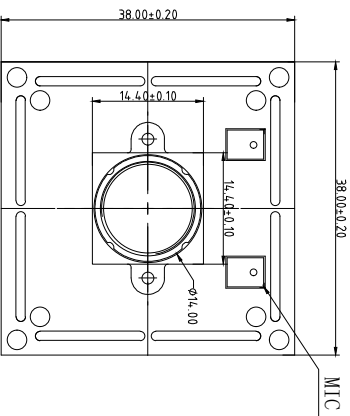
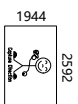

TOP VIEW

SIDE VIEW

BOTTOM VIEW

Parameter:

1、Sensor specification:
 Image Sensor: IMX335
 Pixel: 2.0umx2.0um
 Lens Type: 1/2.8
 Important Voltage Description: USB 5V
 (external power supply);

2、Lens specification:

FOV: 90°(D)
 F/NO.: 2.4
 TV distortion: -2.0%
 Focal length: 3.0
 Composition: 3G2P+IR FILTER
 IR Cut Coating: 650nm±10nm@50%

Designed By	Kevin	Model Name:	USB-003-0789		
Checked By	Aouly_Yan	Projection Type:	Unit:	Material:	-----
		Third Angle	mm	Sheet:	1 of 1
			Scale:	Version:	1/0
			1:1		

[Product Information]

Ver.1.0

IMX335LLN

Diagonal 6.52 mm (Type 1 / 2.8) CMOS Solid-state Image Sensor with Square Pixel for Monochrome Cameras

Description

The IMX335LLN is a diagonal 6.52 mm (Type 1 / 2.8) CMOS active pixel type solid-state image sensor with a square pixel array and 5.14 M effective pixels. This chip operates with analog 2.9 V, digital 1.2 V, and interface 1.8 V triple power supply, and has low power consumption. High sensitivity, low dark current and no smear are achieved. This chip features an electronic shutter with variable charge-integration time.

(Applications: Surveillance cameras, FA cameras, Industrial cameras)

Features

- ◆ CMOS active pixel type dots
- ◆ Built-in timing adjustment circuit, H/V driver and serial communication circuit
- ◆ Input frequency: 6 to 27 MHz / 37.125 MHz / 74.25 MHz
- ◆ Number of recommended recording pixels: 2592 (H) × 1944 (V) approx. 5.04 M pixels
- ◆ Readout mode
 - All-pixel scan mode
 - Window cropping mode
 - Vertical / Horizontal direction-normal / inverted readout mode
- ◆ Readout rate
 - Maximum frame rate in All-pixel scan mode 2592(H) × 1944(V) A/D 10-bit : 60 frame/s
- ◆ High dynamic range (HDR) function
 - Multiple exposure HDR
 - Digital overlap HDR
- ◆ Variable-speed shutter function (resolution 1H units)
- ◆ 10-bit / 12-bit A/D converter
- ◆ CDS / PGA function
 - 0 dB to 30 dB : Analog Gain 30 dB (step pitch 0.3 dB)
 - 30.3 dB to 72 dB : Analog Gain 30 dB + Digital Gain 0.3 to 42 dB (step pitch 0.3 dB)
- ◆ Supports I/O
 - CSI-2 serial data output (2 Lane / 4 Lane, RAW10 / RAW12 output)
- ◆ Recommended exit pupil distance: -100 mm to $-\infty$

STARVIS

* STARVIS is a trademark of Sony Corporation. The STARVIS is back-illuminated pixel technology used in CMOS image sensors for surveillance camera applications. It features a sensitivity of 2000 mV or more per $1 \mu\text{m}^2$ (color product, when imaging with a 706 cd/m² light source, F5.6 in 1 s accumulation equivalent), and realizes high picture quality in the visible-light and near infrared light regions.

Sony reserves the right to change products and specifications without prior notice.

Sony logo is a registered trademark of Sony Corporation.

Device Structure

◆ CMOS image sensor	
◆ Image size	Type 1/2.8
◆ Total number of pixels	2704 (H) × 2104 (V) approx. 5.69 M pixels
◆ Number of effective pixels	2616 (H) × 1964 (V) approx. 5.14 M pixels
◆ Number of active pixels	2616 (H) × 1960 (V) approx. 5.13 M pixels
◆ Number of recommended recording pixels	2592 (H) × 1944 (V) approx. 5.04 M pixels
◆ Unit cell size	2.0 μm (H) × 2.0 μm (V)
◆ Optical black	Horizontal (H) direction: Front 0 pixel, rear 0 pixel Vertical (V) direction: Front 13 pixels, rear 0 pixel
◆ Dummy	Horizontal (H) direction: Front 0 pixel, rear 0 pixel Vertical (V) direction: Front 0 pixel, rear 0 pixel
◆ Package	88 pin BGA

Image Sensor Characteristics

(Tj = 60 °C)

Item		Value	Remarks
Sensitivity (F8)	Typ.	1961 Digit	1/30 s accumulation 12 bit converted value
Saturation signal	Min.	3895 Digit	12 bit converted value

Basic Drive Mode

Drive mode	Recommended number of recording pixels	Maximum frame rate [frame/s]	Output interface	ADC [bit]
All pixel	2592 (H) × 1944 (V) approx. 5.04 M pixels	60	CSI-2	10

[Product Information]

IMX335LQN

Ver.1.1

Diagonal 6.52 mm (Type 1/2.8) CMOS Solid-state Image Sensor with Square Pixel for Color Cameras

Description

The IMX335LQN is a diagonal 6.52 mm (Type 1/2.8) CMOS active pixel type solid-state image sensor with a square pixel array and 5.14 M effective pixels. This chip operates with analog 2.9 V, digital 1.2 V, and interface 1.8 V triple power supply, and has low power consumption. High sensitivity, low dark current and no smear are achieved through the adoption of R, G and B primary color mosaic filters. This chip features an electronic shutter with variable charge-integration time.

(Applications: Surveillance cameras, FA cameras, Industrial cameras)

Features

- ◆ CMOS active pixel type dots
- ◆ Built-in timing adjustment circuit, H/V driver and serial communication circuit
- ◆ Input frequency: 6 to 27 MHz / 37.125 MHz / 74.25 MHz
- ◆ Number of recommended recording pixels: 2592 (H) × 1944 (V) approx. 5.04 M pixels
- ◆ Readout mode
 - All-pixel scan mode
 - Horizontal/Vertical 2/2-line binning mode
 - Window cropping mode
 - Vertical / Horizontal direction-normal / inverted readout mode
- ◆ Readout rate
 - Maximum frame rate in All-pixel scan mode 2592 (H) × 1944 (V) A/D 10-bit : 60 frame/s
- ◆ High dynamic range (HDR) function
 - Multiple exposure HDR
 - Digital overlap HDR
- ◆ Variable-speed shutter function (resolution 1H units)
- ◆ 10-bit / 12-bit A/D converter
- ◆ CDS / PGA function
 - 0 dB to 30 dB : Analog Gain 30 dB (step pitch 0.3 dB)
 - 30.3 dB to 72 dB : Analog Gain 30 dB + Digital Gain 0.3 to 42 dB (step pitch 0.3 dB)
- ◆ Supports I/O
 - CSI-2 serial data output (2 Lane / 4 Lane, RAW10 / RAW12 output)
- ◆ Recommended exit pupil distance: -30 mm to $-\infty$

STARVIS

* STARVIS is a trademark of Sony Corporation. The STARVIS is back-illuminated pixel technology used in CMOS image sensors for surveillance camera applications. It features a sensitivity of 2000 mV or more per $1 \mu\text{m}^2$ (color product, when imaging with a 706 cd/m^2 light source, F5.6 in 1 s accumulation equivalent), and realizes high picture quality in the visible-light and near infrared light regions.

Sony reserves the right to change products and specifications without prior notice.

Sony logo is a registered trademark of Sony Corporation.

Device Structure

◆ CMOS image sensor	
◆ Image size	Type 1/2.8
◆ Total number of pixels	2704 (H) × 2104 (V) approx. 5.69 M pixels
◆ Number of effective pixels	2616 (H) × 1964 (V) approx. 5.14 M pixels
◆ Number of active pixels	2616 (H) × 1960 (V) approx. 5.11 M pixels
◆ Number of recommended recording pixels	2592 (H) × 1944 (V) approx. 5.04 M pixels
◆ Unit cell size	2.0 μm (H) × 2.0 μm (V)
◆ Optical black	Horizontal (H) direction: Front 0 pixel, rear 0 pixel Vertical (V) direction: Front 13 pixels, rear 0 pixel
◆ Dummy	Horizontal (H) direction: Front 0 pixel, rear 0 pixel Vertical (V) direction: Front 0 pixel, rear 0 pixel
◆ Package	88 pin CSP BGA

Image Sensor Characteristics

(T_j = 60 °C)

Item		Value	Remarks
Sensitivity (F5.6)	Typ.	2200 Digit	1/30 s accumulation 12 bit converted value
Saturation signal	Min.	3895 Digit	12 bit converted value

Basic Drive Mode

Drive mode	Recommended number of recording pixels	Maximum frame rate [frame/s]	Output interface	ADC [bit]
All pixel	2592 (H) × 1944 (V) approx. 5.04 M pixels	60	CSI-2	10
Horizontal/ Vertical 2/2-line binning	1296 (H) × 972 (V) approx. 1.26 M pixels	60	CSI-2	10



YDS CAMERA MODULE

your best camera partner

Camera Module Pinout Definition Reference Chart

OmniVision	Sony	Samsung	On-Semi	Aptina	Himax	GalaxyCore	PixArt	SmartSens	Sensors
Pin Signal		Description							
DGND	GND								ground for digital circuit
AGND									ground for analog circuit
PCLK	DCK								DVP PCLK output
XCLR	PWDN	XSHUTDOWN	STANDBY						power down active high with internal pull-down resistor
MCLK	XVCLK	XCLK	INCK						system input clock
RESET	RST								reset active low with internal pull-up resistor
NC	NULL								no connect
SDA	SIO_D	SIOD							SCCB data
SCL	SIO_C	SIOC							SCCB input clock
VSYNC	XVS	FSYNC							DVP VSYNC output
HREF	XHS								DVP HREF output
DOVDD									power for I/O circuit
AFVDD									power for VCM circuit
AVDD									power for analog circuit
DVDD									power for digital circuit
STROBE	FSTROBE								strobe output
FSIN									synchronize the VSYNC signal from the other sensor
SID									SCCB last bit ID input
ILPWM									mechanical shutter output indicator
FREX									frame exposure / mechanical shutter
GPIO									general purpose inputs
SLASEL									I2C slave address select
AFEN									CEN chip enable active high on VCM driver IC
MIPI Interface									
MDN0	DN0	MD0N	DATA_N	DMO1N					MIPI 1st data lane negative output
MDP0	DP0	MD0P	DATA_P	DMO1P					MIPI 1st data lane positive output
MDN1	DN1	MD1N	DATA2_N	DMO2N					MIPI 2nd data lane negative output
MDP1	DP1	MD1P	DATA2_P	DMO2P					MIPI 2nd data lane positive output
MDN2	DN2	MD2N	DATA3_N	DMO3N					MIPI 3rd data lane negative output
MDP2	DP2	MD2P	DATA3_P	DMO3P					MIPI 3rd data lane positive output
MDN3	DN3	MD3N	DATA4_N	DMO4N					MIPI 4th data lane negative output
MDP3	DP3	MD3P	DATA4_P	DMO4P					MIPI 4th data lane positive output
MCN	CLKN	CLK_N	DCKN						MIPI clock negative output
MCP	CLKP	CLK_P	DCKN						MIPI clock positive output
DVP Parallel Interface									
D0	DO0	Y0							DVP data output port 0
D1	DO1	Y1							DVP data output port 1
D2	DO2	Y2							DVP data output port 2
D3	DO3	Y3							DVP data output port 3
D4	DO4	Y4							DVP data output port 4
D5	DO5	Y5							DVP data output port 5
D6	DO6	Y6							DVP data output port 6
D7	DO7	Y7							DVP data output port 7
D8	DO8	Y8							DVP data output port 8
D9	DO9	Y9							DVP data output port 9
D10	DO10	Y10							DVP data output port 10
D11	DO11	Y11							DVP data output port 11

www.YDSCAM.com sales@ydscam.com Phone (WeChat, QQ): (+86) 177 2732 6718

All rights reserved @ YingDeShun Co. Ltd. Specifications subject to change without notice.

Cameras Applications



IMAGING DEVICES



Camera Reliability Test

Reliability Inspection Item		Testing Method	Acceptance Criteria	
Category	Item			
Environmental	Storage Temperature	High 60°C 96 Hours	Temperature Chamber	No Abnormal Situation
		Low -20°C 96 Hours	Temperature Chamber	No Abnormal Situation
	Operation Temperature	High 60°C 24 Hours	Temperature Chamber	No Abnormal Situation
		Low -20°C 24 Hours	Temperature Chamber	No Abnormal Situation
	Humidity	60°C 80% 24 Hours	Temperature Chamber	No Abnormal Situation
	Thermal Shock	High 60°C 0.5 Hours Low -20°C 0.5 Hours Cycling in 24 Hours	Temperature Chamber	No Abnormal Situation
Physical	Drop Test (Free Falling)	Without Package 60cm	10 Times on Wood Floor	Electrically Functional
		With Package 60cm	10 Times on Wood Floor	Electrically Functional
	Vibration Test	50Hz X-Axis 2mm 30min	Vibration Table	Electrically Functional
		50Hz Y-Axis 2mm 30min	Vibration Table	Electrically Functional
		50Hz Z-Axis 2mm 30min	Vibration Table	Electrically Functional
	Cable Tensile Strength Test	Loading Weight 4 kg 60 Seconds Cycling in 24 Hours	Tensile Testing Machine	Electrically Functional
Electrical	ESD Test	Contact Discharge 2 KV	ESD Testing Machine	Electrically Functional
		Air Discharge 4 KV	ESD Testing Machine	Electrically Functional
	Aging Test	On/Off 30 Seconds Cycling in 24 Hours	Power Switch	Electrically Functional
	USB Connector	On/Off 250 Times	Plug and Unplug	Electrically Functional





YDS CAMERA MODULE

your best camera partner

Camera Inspection Standard

Inspection Item		Inspection Method	Standard of Inspection		
Category	Item				
Appearance	FPC/ PCB	Color	The Naked Eye	Major Difference is Not Allowed.	
		Be Torn/Chopped	The Naked Eye	Copper Crack Exposure is Not Allowed.	
		Marking	The Naked Eye	Clear, Recognizable (Within 30cm Distance)	
	Holder	Scratches	The Naked Eye	The Inside Crack Exposure is Not Allowed	
		Gap	The Naked Eye	Meet the Height Standard	
		Screw	The Naked Eye	Make Sure Screws Are Presented (If Any)	
		Damage	The Naked Eye	The Inside Crack Exposure is Not Allowed	
	Lens	Scratch	The Naked Eye	No Effect On Resolution Standard	
		Contamination	The Naked Eye	No Effect On Resolution Standard	
		Oil Film	The Naked Eye	No Effect On Resolution Standard	
		Cover Tape	The Naked Eye	No Issue On Appearance.	
	Function	Image	No Communication	Test Board	Not Allowed
			Bright Pixel	Black Board	Not Allowed In the Image Center
Dark Pixel			White board	Not Allowed In the Image Center	
Blurry			The Naked Eye	Not Allowed	
No Image			The Naked Eye	Not Allowed	
Vertical Line			The Naked Eye	Not Allowed	
Horizontal Line			The Naked Eye	Not Allowed	
Light Leakage			The Naked Eye	Not Allowed	
Blinking Image			The Naked Eye	Not Allowed	
Bruise			Inspection Jig	Not Allowed	
Resolution			Chart	Follows Outgoing Inspection Chart Standard	
Color			The Naked Eye	No Issue	
Noise			The Naked Eye	Not Allowed	
Corner Dark			The Naked Eye	Less Than 100px By 100px	
Color Resolution			The Naked Eye	No Issue	
Dimension	Height	The Naked Eye	Follows Approval Data Sheet		
	Width	The Naked Eye	Follows Approval Data Sheet		
	Length	The Naked Eye	Follows Approval Data Sheet		
	Overall	The Naked Eye	Follows Approval Data Sheet		

www.YDSCAM.com sales@ydscam.com Phone (WeChat, QQ): (+86) 177 2732 6718

All rights reserved @ YingDeShun Co. Ltd. Specifications subject to change without notice.

YDSCAM Package Solutions

YDS Camera Module



Complete with Lens Protection Film



Tray with Grid and Space



Place Cameras on the Tray



YDSCAM Package Solutions

Full Tray of Cameras



Cover Tray with Lid



Place Tray into Anti-Static Bag



Vacuum the Anti-Static Bag



YDSCAM Package Solutions

Sealed Vacuum Anti-Static Bag with Labels

1. Model and Description 2. Quantity 3. Manufacturing Date Code 4. Caution



YDSCAM Package Solutions

Place Foam Sheets Between Tray Bags



Foam Sheets are Larger Than Trays



Place Foam Sheets and Trays into Box



Foam Sheets are Tightly Fitting in Box



Seal the Carbon Box



Label the Carbon Shipping Box





YDSCAM Package Solutions

USB Camera Module

Complete with Lens Protection Film



Place Camera Sample into Anti-Static Bag

Place USB Cameras into Tray



Seal the Tray with Anti-Static Bag

Label the Carbon Shipping Box



YDSCAM Package Solutions

Place Camera Sample into Anti-Static Bag



Place Connectors into Anti-Static Bag



Label the Sample Bags



Place Connectors into Reel



Place Samples into the Carbon Box



Place Connectors into the Carbon Box





YDS CAMERA MODULE

your best camera partner

Company YDSCAM

YingDeShun Co. Ltd. (YDS) was established in 2017, a next-generation technology driven manufacturer specialized in research, design, and produce of audio and video products. YDS is occupying 20,000 square feet automated plants with 100 employees of annual throughput 30,000,000 units cameras.

YDS provides OEM, ODM design, contract manufacturing, and builds the camera products. You may provide the requirements to us, even with a hand draft, our sales and engineering work together to meet your needs. We consider ourselves your last-term partner in developing practical and innovative solutions.

Our team covers everything from initial concept development to mass produced product. YDS specializes in customized camera design, raw material, electronic engineering, firmware/software development, product testing, and packing design. Our experienced strategic supply systems offer a robust and dependable manufacturing capacity for orders of various sizes.

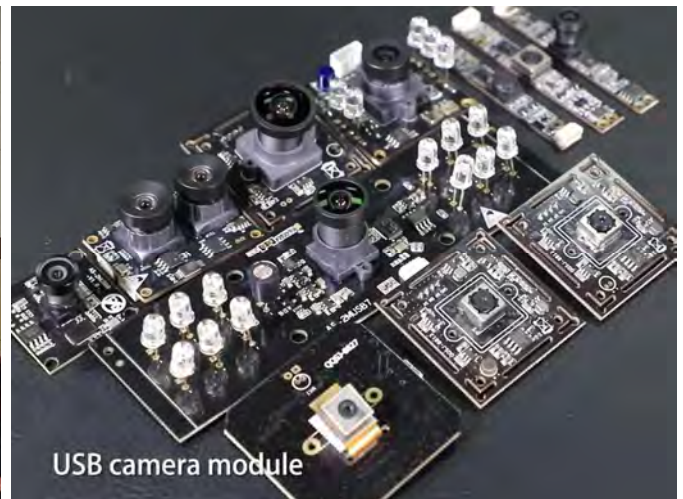

Limited Warranty

YDS provides the following limited warranty if you purchased the Product(s) directly from YDS company or from YDS's website www.YDSCAM.com. Product(s) purchased from other sellers or sources are not covered by this Limited Warranty. YDS guarantees that the Product(s) will be free from defects in materials and workmanship under normal use for a period of one (1) year from the date you receive the product ("Warranty Period").

For all Product(s) that contain or develop material defects in materials or workmanship during the Warranty Period, YDS will, at its sole option, either: (i) repair the Product(s); (ii) replace the Product(s) with a new or refurbished Product(s) (replacement Product(s) being of identical model or functional equivalent); or (iii) provide you a refund of the price you paid for the Product(s).

This Limited Warranty of YDS is solely limited to repair and/or replacement on the terms set forth above. YDS is not reliable or responsible for any subsequent events.



www.YDSCAM.com sales@ydscam.com Phone (WeChat, QQ): (+86) 177 2732 6718

All rights reserved @ YingDeShun Co. Ltd. Specifications subject to change without notice.



YDS CAMERA MODULE

your best camera partner

YDS Strength

Powerful Factory



Professional Service



Promised Delivery



www.YDSCAM.com sales@ydscam.com Phone (WeChat, QQ): (+86) 177 2732 6718

All rights reserved @ YingDeShun Co. Ltd. Specifications subject to change without notice.